



ASSEMBLED SOCKET-COMBINATION

Enclosure

extra strong, schock-resistant
easily open, it provides a comfortable mount
it can be connected across a cable gland
it consists of a 35 mm mounting rail

Window

6 modules width
(12 pcs breakable lamellas)
transparent
flap-covered
padlockable

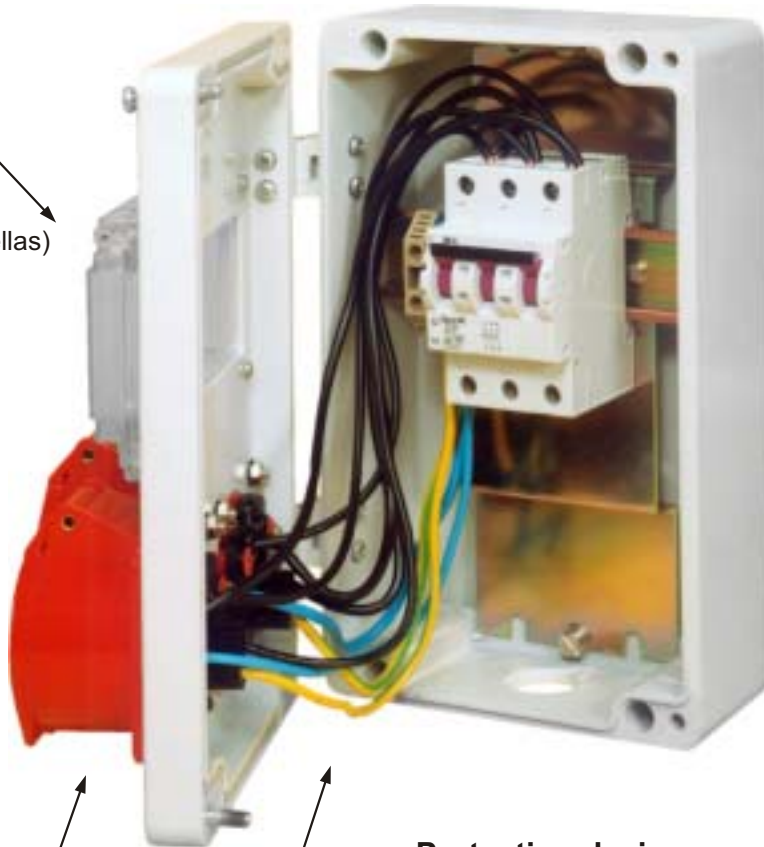

Versions of sockets

single-phase 3p, 16 A with earthed contact
CEE 4p, 16 A or 32 A
CEE 5p, 16 A or 32 A

Wires of enclosure (inside) are

flexible
correct by colour
finish in ferrule
connect to terminals (neutral and protecting wires)

Protecting devices

- miniature circuit breakers
with optional rated current
- residual current circuit breakers

Applicable

- rotary switches
- signalling lamps

Degree of protection of socket-combinations: IP 44

Assembled socket-combinations type CsK

Application

CsK... equipment-combinations are suitable for plugging connection, for protection against overcurrents and short-circuit currents and for switching ON - OFF of electrical loading equipment. Its application is recommended in the following places: industrial and agricultural establishments, building machines, temporary construction site, workshops, containers, family-houses, hobby-rooms, country-cottages, camps, etc.

Structure

The base of the combination-family is an enclosure from material polyester strengthening with fibreglass.

Dimensions: 160×260×90 mm and 255×250×120 mm. The cover of enclosure consists of a flap-covered transparent, by request padlockable window with 6 module width (12 breakable lamellas), in addition sockets, rotary switches and signalling lamps.

Behind the window is a 35 mm rail by EN 50022 standard for snap of clamps and protecting devices. The cover joins to the vessel with 2 pcs hinges on the left side and by unscrew of 2 pcs screws the enclosure can be opened. This solution makes possible a quick and comfortable mounting. The internal wiring is well dimensioned, well arranged.

Assortment of the flap-covered sockets:

- single-phase 16A: phase, N, earth, 16 A, 230 V, blue
- CEE 4p 16A: 3 phases, earth, 16 A, 400 V, red
- CEE 4p 32A: 3 phases, earth, 32 A, 400 V, red
- CEE 5p 16A: 3 phases, N, earth, 16 A, 400 V, red
- CEE 5p 32A: 3 phases, N, earth, 32 A, 400 V, red

Mounting, connection

The apparatus should be fastened on a vertical plate according to the legible position of the inscription with 4 pcs M5×30 screws. The fixing dimensions can be found in the purchasing information enclosed to combination and on the back side of enclosure.

It can be connected -from below or above- across Pm16 or Pm21 cable glands or by iron conduit pipe. The not used connecting hole can be closed with a screw plug.

Cross-section of connecting wires:

| Rated current of the socket [A] | Cross-section of wires [mm ²] | |
|---------------------------------|---|------|
| | min. | max. |
| 16 | 1,5 | 4 |
| 32 | 4 | 10 |

Without connection of earth terminal do not energize the socket-combination!

Technical data

| | |
|---|-----------------------------------|
| Rated insulation voltage | 250 V 50 Hz |
| - with single phase socket | 400 V 50 Hz |
| - with three phase socket | 230/400 V 50 Hz |
| Rated operational voltage | |
| Protection class against electric shock | I. |
| Degree of protection | IP 44 |
| Ambient temperature | -20... +40 °C |
| Pollution degree | 3 (normal industrial environment) |
| Relevant standard | EN 60439 |

The devices need no maintenance, they are available in substance-protecting boxes.

Dimensions

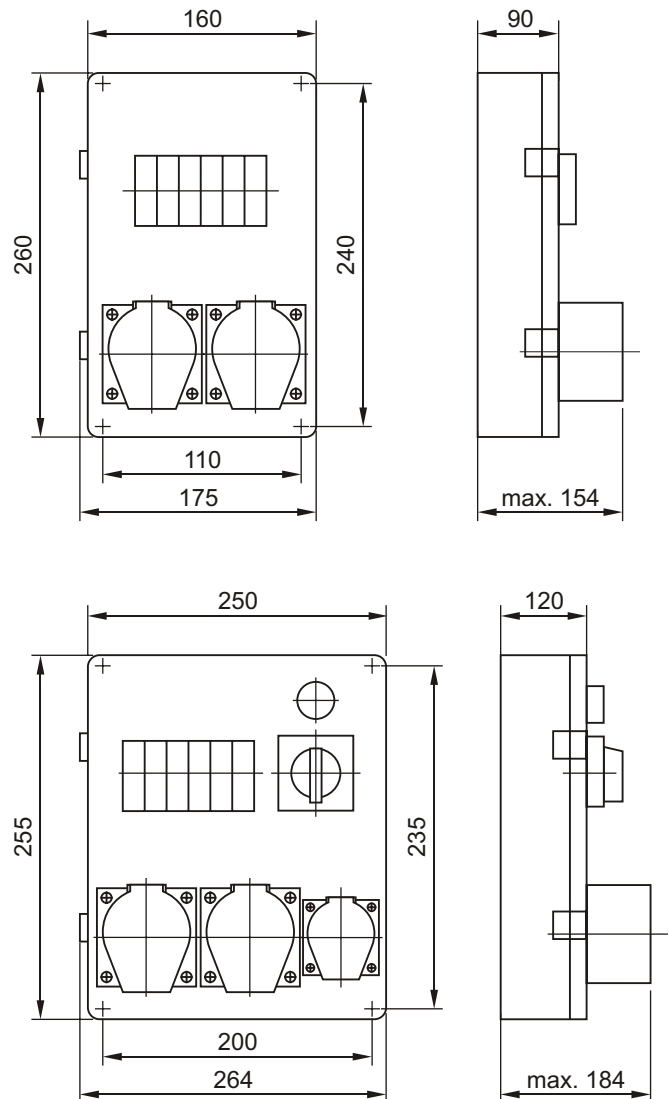

Assembled socket-combinations type CsK

Versions

From following tables you can chose the requested socket-combinations and you can order them by putting the type-sign.

The last three number of type-sign (code) - going from left to right - codes the rated current of the built-in miniature circuit breaker (MCB) with characteristic "C" as follows:

| | |
|-----------------|--------|
| 0: there is not | 5: 13A |
| 1: 2A | 6: 16A |
| 2: 4A | 7: 20A |
| 3: 6A | 8: 25A |
| 4: 10A | 9: 32A |

The manufacturer assembles RCCB $I_{\Delta n}=25\text{ A}$ to sockets 16 A and it assembles RCCB $I_{\Delta n}=40\text{ A}$ to sockets 32 A.

If the combination do not consist of any protecting devices, the customer can mount other electric element too.

Several versions are available but for the consumers request specific socket-combinations are also workable by the manufacturer.

Socket-combinations assembled with 2 pcs three-phase sockets and flap-covered window

| Design | Socket | MCB* | RCCB* | Code |
|--|--------------------------------------|------------------------------|---------------------|---------------------|
|  Front-view: 160×260 mm | 2 pcs CEE 4p 16 A | - | - | CsK 5100-000 |
| | 2 pcs CEE 4p 16 A | 1 pc 3p 16 A | - | CsK 5101-600 |
| | 2 pcs CEE 4p 16 A | - | 25 A / 30 mA, 4p | CsK 5102-000 |
| | 2 pcs CEE 4p 16 A | 2 pcs 3p 16 A | - | CsK 5103-660 |
| | 1 pc CEE 4p 16 A 1 pc CEE 4p 32 A | - | - | CsK 5120-000 |
| | 1 pc CEE 4p 16 A 1 pc CEE 4p 32 A | - | 40 A / 30 mA, 4p | CsK 5122-000 |
| | 1 pc CEE 4p 16 A 1 pc CEE 4p 32 A | 1 pc 3p 16 A 1 pc 3p 32 A | - | CsK 5123-690 |
| | 2 pcs CEE 5p 16 A | - | - | CsK 5140-000 |
| | 2 pcs CEE 5p 16 A | 1 pc 3p 16 A | - | CsK 5141-600 |
| | 2 pcs CEE 5p 16 A | - | 25 A / 30 mA, 4p | CsK 5142-000 |
| | 2 pcs CEE 5p 16 A | 2 pcs 3p 16 A | - | CsK 5143-660 |
| | 1 pc CEE 5p 16 A 1 pc CEE 5p 32 A | - | - | CsK 5160-000 |
| | 1 pc CEE 5p 16 A 1 pc CEE 5p 32 A | - | 40 A / 30 mA, 4p | CsK 5162-000 |
| | 1 pc CEE 5p 16 A 1 pc CEE 5p 32 A | 1 pc 3p 16 A 1 pc 3p 32 A | - | CsK 5163-690 |
| | 2 pcs CEE 4p 32 A | - | - | CsK 5180-000 |
| | 2 pcs CEE 4p 32 A | 1 pc 3p 32 A | - | CsK 5181-900 |
| | 2 pcs CEE 4p 32 A | - | 40 A / 30 mA, 4p | CsK 5182-000 |
| | 2 pcs CEE 4p 32 A | 2 pcs 3p 32 A | - | CsK 5183-990 |
| | 2 pcs CEE 5p 32 A | - | - | CsK 5200-000 |
| | 2 pcs CEE 5p 32 A | 1 pc 3p 32 A | - | CsK 5201-900 |
| 2 pcs CEE 5p 32 A | - | 25 A / 30 mA, 4p | CsK 5202-000 | |
| 2 pcs CEE 5p 32 A | 2 pcs 3p 32 A | - | CsK 5203-990 | |
| Manufacturer works out further versions by specific request | | | | |

* 1p: single-pole MCB
2p: two-pole MCB or RCCB
3p: three-pole MCB
4p: four-pole RCCB

Assembled socket-combinations type CsK

Socket-combinations assembled with single- and three-phase sockets, and flap-covered window

| Design | Socket | MCB | RCCB | Code |
|---|---|------------------------------|------------------|---------------------|
|  <p>Front-view: 160×260 mm</p> | 1 pc single phase 16 A 1 pc CEE 4p 16 A | - | - | CsK 5020-000 |
| | 1 pc single phase 16 A 1 pc CEE 4p 16 A | 1 pc 1p 16 A 1 pc 3p 16 A | - | CsK 5021-660 |
| | 1 pc single phase 16 A 1 pc CEE 4p 16 A | - | 25 A / 30 mA, 4p | CsK 5022-000 |
| | 1 pc single phase 16 A 1 pc CEE 5p 16 A | - | - | CsK 5040-000 |
| | 1 pc single phase 16 A 1 pc CEE 5p 16 A | 1 pc 1p 16 A 1 pc 3p 16 A | - | CsK 5041-660 |
| | 1 pc single phase 16 A 1 pc CEE 5p 16 A | - | 25 A / 30 mA, 4p | CsK 5042-000 |
| | 1 pc single phase 16 A 1 pc CEE 5p 16 A | 1 pc 2p 16 A 1 pc 3p 16 A | - | CsK 5043-660 |
| | 1 pc single phase 16 A 1 pc CEE 4p 32 A | - | - | CsK 5060-000 |
| | 1 pc single phase 16 A 1 pc CEE 4p 32 A | 1 pc 1p 16 A 1 pc 3p 32 A | - | CsK 5061-690 |
| | 1 pc single phase 16 A 1 pc CEE 4p 32 A | - | 40 A / 30 mA, 4p | CsK 5062-000 |
| | 1 pc single phase 16 A 1 pc CEE 5p 32 A | - | - | CsK 5080-000 |
| | 1 pc single phase 16 A 1 pc CEE 5p 32 A | 1 pc 1p 16 A 1 pc 3p 32 A | - | CsK 5081-690 |
| | 1 pc single phase 16 A 1 pc CEE 5p 32 A | - | 40 A / 30 mA, 4p | CsK 5082-000 |
| | Manufacturer works out further versions by specific request | | | |

Socket-combinations assembled with single-phase sockets and flap-covered window

| Design | Socket | MCB | RCCB | Code |
|---|---|---------------|------------------|---------------------|
|  <p>Front-view: 160×260 mm</p> | 2 pcs singlephase 16 A | - | - | CsK 5001-000 |
| | 2 pcs singlephase 16 A | 2 pcs 1p 16 A | - | CsK 5002-660 |
| | 2 pcs singlephase 16 A | - | 25 A / 30 mA, 2p | CsK 5003-000 |
| | 2 pcs singlephase 16 A | 2 pcs 1p 16 A | 25 A / 30 mA, 2p | CsK 5004-660 |
| | 2 pcs singlephase 16 A | 1 pc 2p 16 A | - | CsK 5005-600 |
| | 2 pcs singlephase 16 A | 2 pcs 2p 16 A | - | CsK 5006-660 |
| | Manufacturer works out further versions by specific request | | | |

Assembled socket-combinations type CsK

Socket-combinations assembled with three-phase socket, rotary switch and flap-covered window

| Design | Socket | MCB | RCCB | Code |
|--|------------------|--------------|------------------|---------------------|
|  <p>Front-view: 160x260 mm Rotary switch: KK1-32 ON-OFF</p> | 1 pc CEE 4p 16 A | - | - | CsK 5301-000 |
| | 1 pc CEE 4p 16 A | 1 pc 3p 16 A | - | CsK 5302-600 |
| | 1 pc CEE 4p 16 A | - | 25 A / 30 mA, 4p | CsK 5303-000 |
| | 1 pc CEE 4p 32 A | - | - | CsK 5304-000 |
| | 1 pc CEE 4p 32 A | 1 pc 3p 32 A | - | CsK 5305-900 |
| | 1 pc CEE 4p 32 A | - | 40 A / 30 mA, 4p | CsK 5306-000 |
| | 1 pc CEE 5p 16 A | - | - | CsK 5307-000 |
| | 1 pc CEE 5p 16 A | 1 pc 3p 16 A | - | CsK 5308-600 |
| | 1 pc CEE 5p 16 A | - | 25 A / 30 mA, 4p | CsK 5309-000 |
| | 1 pc CEE 5p 32 A | - | - | CsK 5310-000 |
| | 1 pc CEE 5p 32 A | 1 pc 3p 32 A | - | CsK 5311-900 |
| | 1 pc CEE 5p 32 A | - | 40 A / 30 mA, 4p | CsK 5312-000 |
| Manufacturer works out further versions by specific request | | | | |

Socket combinations with rotary switch in enclosure

| Design | Socket | Rotary switch | Positions of rotary switch | Code |
|---|--|---------------|----------------------------|-----------------------|
|  <p>Place: 100x100 mm Height: 141 mm</p> | 2 pcs single phase 16 A | KK0-20 | 1, 0, 2 | CsKK0-16-6688 |
| | 2 pcs single phase 16 A | KK0-20 | 1, 0, 2, 1+2 | CsKK0-16-4619 |
| | 2 pcs single phase 16 A switch-disconnector | KK0-20 | 0, 1 | CsKKS0-16-9689 |
| | 2 pcs single phase 16 A switch-disconnector | KK0-20 | 0, 1 | CsKKV0-16-9689 |
| Manufacturer works out further versions by specific request | | | | |

Socket-combinations assembled with 2 pcs three-phase sockets and 2 pcs rotary switches

| Design | Socket | MCB | RCCB | Code |
|--|---|-----|------|---------------------|
|  <p>Front-view: 160x260 mm Rotary switches: KK1-32 ON-OFF</p> | 2 pcs CEE 4p 16 A | - | - | CsK 5501-000 |
| | 2 pcs CEE 5p 16 A | - | - | CsK 5502-000 |
| | 2 pcs CEE 4p 32 A | - | - | CsK 5503-000 |
| | 2 pcs CEE 5p 32 A | - | - | CsK 5504-000 |
| | 1 pc CEE 4p 16 A 1 pc CEE 4p 32 A | - | - | CsK 5505-000 |
| | 1 pc CEE 5p 16 A 1 pc CEE 5p 32 A | - | - | CsK 5506-000 |
| | Manufacturer works out further versions by specific request | | | |

Assembled socket-combinations type CsK

Socket-combinations assembled with single- and three-phase sockets and 2 pcs rotary switches

| Design | Socket | MCB | RCCB | Code |
|--|--|-----|------|---------------------|
|  <p>Front-view: 160×260 mm Rotary switches: KK0-20 ON-OFF KK1-32 ON-OFF</p> | 1 pc single phase 16 A 1 pc CEE 4p 16 A | - | - | CsK 5801-000 |
| | 1 pc single phase 16 A 1 pc CEE 4p 32 A | - | - | CsK 5802-000 |
| | 1 pc single phase 16 A 1 pc CEE 5p 16 A | - | - | CsK 5803-000 |
| | 1 pc single phase 16 A 1 pc CEE 5p 32 A | - | - | CsK 5804-000 |
| Manufacturer works out further versions by specific request | | | | |

Socket-combinations assembled with single-phase sockets, 2 pcs rotary switches and signalling lamps

| Design | Socket | MCB | RCCB | Code |
|--|-------------------------|-----|------|---------------------|
|  <p>Front-view: 160×260 mm Rotary switches: 2 pcs KK1-32 ON-OFF Signalling lamps: 2 pcs</p> | 4 pcs single phase 16 A | - | - | CsK 5820-000 |
| Manufacturer works out further versions by specific request | | | | |

Assembled socket-combinations type CsK

Socket-combinations assembled with single- and three-phase sockets with 3 pcs rotary switches



| Design | Socket | MCB | RCCB | Code |
|--|--|-----|------|---------------------|
|  <p>Front-view: 250×255 mm Rotary switch: 3 pcs KK1-32 ON-OFF</p> | 3 pcs single phase 16 A 3 pcs CEE 4p 16 A | - | - | CsK 6031-000 |
| | 3 pcs single phase 16 A 3 pcs CEE 5p 16 A | - | - | CsK 6032-000 |
| | 3 pcs single phase 16 A 1 pc CEE 4p 32 A 2 pcs CEE 4p 16 A | - | - | CsK 6035-000 |
| | 3 pcs single phase 16 A 1 pc CEE 5p 32 A 2 pcs CEE 4p 16 A | - | - | CsK 6036-000 |
| Manufacturer works out further versions by specific request | | | | |

Socket-combinations assembled with single- and three-phase sockets, signalling lamps and flap-covered window

| Design | Socket | MCB | RCCB | Code | |
|--|---|-------------------------------|------------------|---------------------|---------------------|
|  <p>Front-view: 250×255 mm Signalling lamps: 3 pcs</p> | 4 pcs single phase 16 A 1 pc CEE 4p 16 A | - | - | CsK 6111-000 | |
| | 4 pcs single phase 16 A 1 pc CEE 5p 16 A | - | - | CsK 6112-000 | |
| | 4 pcs single phase 16 A 1 pc CEE 4p 32 A | - | - | CsK 6113-000 | |
| | 4 pcs single phase 16 A 1 pc CEE 5p 32 A | - | - | CsK 6114-000 | |
| | 4 pcs single phase 16 A 1 pc CEE 4p 16 A | - | 40 A / 30 mA, 4p | CsK 6121-000 | |
| | 4 pcs single phase 16 A 1 pc CEE 5p 16 A | - | 40 A / 30 mA, 4p | CsK 6122-000 | |
| | 4 pcs single phase 16 A 1 pc CEE 4p 32 A | - | 40 A / 30 mA, 4p | CsK 6123-000 | |
| | 4 pcs single phase 16 A 1 pc CEE 5p 32 A | - | 40 A / 30 mA, 4p | CsK 6124-000 | |
| | 4 pcs single phase 16 A 1 pc CEE 4p 16 A | 2 pcs 1p 16 A 1 pc 3p 16 A | - | - | CsK 6131-666 |
| | 4 pcs single phase 16 A 1 pc CEE 5p 16 A | 2 pcs 1p 16 A 1 pc 3p 16 A | - | - | CsK 6132-666 |
| | 4 pcs single phase 16 A 1 pc CEE 4p 32 A | 2 pcs 1p 16 A 1 pc 3p 32 A | - | - | CsK 6133-669 |
| | 4 pcs single phase 16 A 1 pc CEE 5p 32 A | 2 pcs 1p 16 A 1 pc 3p 32 A | - | - | CsK 6134-669 |
| | Manufacturer works out further versions by specific request | | | | |

Assembled socket-combinations type CsK

Socket-combinations assembled with single- and three-phase sockets, rotary switch, signalling lamp and flap -covered window

| Design | Socket | MCB | RCCB | Code |
|---|--|------------------------------|------------------|---------------------|
|  <p>Front-view: 250×255 mm Rotary switch: 1 pc KK1-32 ON-OFF or 1 pc KK2-63 ON-OFF Signalling lamp: 1 pc</p> | 1 pc single phase 16 A 2 pcs CEE 4p 16 A | - | - | CsK 6211-000 |
| | 1 pc single phase 16 A 2 pcs CEE 5p 16 A | - | - | CsK 6212-000 |
| | 1 pc single phase 16 A 2 pcs CEE 4p 32 A | - | - | CsK 6213-000 |
| | 1 pc single phase 16 A 2 pcs CEE 5p 32 A | - | - | CsK 6214-000 |
| | 1 pc single phase 16 A 1 pc CEE 4p 32 A 1 pc CEE 4p 16 A | - | - | CsK 6215-000 |
| | 1 pc single phase 16 A 1 pc CEE 5p 32 A 1 pc CEE 5p 16 A | - | - | CsK 6216-000 |
| | 1 pc single phase 16 A 2 pcs CEE 4p 16 A | - | 40 A / 30 mA, 4p | CsK 6221-000 |
| | 1 pc single phase 16 A 2 pcs CEE 5p 16 A | - | 40 A / 30 mA, 4p | CsK 6222-000 |
| | 1 pc single phase 16 A 2 pcs CEE 4p 32 A | - | 40 A / 30 mA, 4p | CsK 6223-000 |
| | 1 pc single phase 16 A 2 pcs CEE 5p 32 A | - | 40 A / 30 mA, 4p | CsK 6224-000 |
| | 1 pc single phase 16 A 1 pc CEE 4p 32 A 1 pc CEE 4p 16 A | - | 40 A / 30 mA, 4p | CsK 6225-000 |
| | 1 pc single phase 16 A 1 pc CEE 5p 32 A 1 pc CEE 5p 16 A | - | 40 A / 30 mA, 4p | CsK 6226-000 |
| Manufacturer works out further versions by specific request | | | | |
|  <p>Front-view: 250×255 mm Rotary switch: 1 pc KK1-32 ON-OFF or 1 pc KK2-63 ON-OFF Signalling lamp: 1 pc</p> | 1 pc single phase 16 A 2 pcs CEE 4p 16 A | 2 pcs 3p 16 A | - | CsK 6231-660 |
| | 1 pc single phase 16 A 2 pcs CEE 5p 32 A | 2 pcs 3p 16 A | - | CsK 6232-660 |
| | 1 pc single phase 16 A 1 pc CEE 4p 32 A 1 pc CEE 4p 16 A | 1 pc 3p 32 A 1 pc 3p 16 A | - | CsK 6233-960 |
| | 1 pc single phase 16 A 1 pc CEE 5p 32 A 1 pc CEE 5p 16 A | 1 pc 3p 32 A 1 pc 3p 16 A | - | CsK 6234-960 |
| | Manufacturer works out further versions by specific request | | | |

Assembled socket-combinations type CsK

Socket-combinations assembled with single- and three-phase sockets, flap-covered window

| Design | Socket | MCB | RCCB | Code |
|---|--|------------------------------|------------------|---------------------|
|  <p>Front-view: 250×255 mm</p> | 4 pcs single phase 16 A 3 pcs CEE 4p 16 A | - | - | CsK 6311-000 |
| | 4 pcs single phase 16 A 3 pcs CEE 5p 16 A | - | - | CsK 6312-000 |
| | 4 pcs single phase 16 A 3 pcs CEE 4p 32 A | - | - | CsK 6313-000 |
| | 4 pcs single phase 16 A 3 pcs CEE 5p 32 A | - | - | CsK 6314-000 |
| | 4 pcs single phase 16 A 1 pc CEE 4p 32 A 2 pcs CEE 4p 16 A | - | - | CsK 6315-000 |
| | 4 pcs single phase 16 A 1 pc CEE 5p 32 A 2 pcs CEE 5p 16 A | - | - | CsK 6316-000 |
| | 4 pcs single phase 16 A 3 pcs CEE 4p 16 A | - | 40 A / 30 mA, 4p | CsK 6321-000 |
| | 4 pcs single phase 16 A 3 pcs CEE 5p 16 A | - | 40 A / 30 mA, 4p | CsK 6322-000 |
| | 4 pcs single phase 16 A 3 pcs CEE 4p 32 A | - | 40 A / 30 mA, 4p | CsK 6323-000 |
| | 4 pcs single phase 16 A 3 pcs CEE 5p 32 A | - | 40 A / 30 mA, 4p | CsK 6324-000 |
| | 4 pcs single phase 16 A 1 pc CEE 4p 32 A 2 pcs CEE 4p 16 A | - | 40 A / 30 mA, 4p | CsK 6325-000 |
| | 4 pcs single phase 16 A 1 pc CEE 5p 32 A 2 pcs CEE 5p 16 A | - | 40 A / 30 mA, 4p | CsK 6326-000 |
| | 4 pcs single phase 16 A 3 pcs CEE 4p 16 A | 2 pcs 3p 16 A | - | CsK 6331-660 |
| | 4 pcs single phase 16 A 3 pcs CEE 5p 16 A | 2 pcs 3p 16 A | - | CsK 6332-660 |
| | 4 pcs single phase 16 A 1 pc CEE 4p 32 A 2 pcs CEE 4p 16 A | 1 pc 3p 32 A 1 pc 3p 16 A | - | CsK 6333-960 |
| | 4 pcs single phase 16 A 1 pc CEE 5p 32 A 2 pcs CEE 5p 16 A | 1 pc 3p 32 A 1 pc 3p 16 A | - | CsK 6334-960 |
| | Manufacturer works out further versions by specific request | | | |



GANZ Kapcsoló- és Készülékgyártó Kft.

Hungary, Budapest X., Kőbányai út 41/c H-1475 Pf.: 87.

Phone: (36-1) 261-1115

Fax: (36-1) 261-7670

e-mail: ganzkk@ganzkk.hu

www.ganzkk.hu

